

Mid-America *RidgeMaster, RidgeMaster Plus and HipMaster* Installation Instructions

New applications for metal, slate and wood shingle roofs (see page 7)

CAUTION: Before beginning installation read all general guidelines, special notes and installation steps thoroughly and be sure to check and follow all your local building codes. Failure to do so may result in improper installation and may void the homeowner's warranty.

Tools needed: hammer, circular saw, chalk line, utility knife or snips, tape measure, caulking gun & roofing sealant.

GENERAL GUIDELINES FOR RIDGEMASTER, RIDGEMASTER PLUS AND HIPMASTER

- RidgeMaster** can accommodate any pitch from 3-12 to 16-12. **RidgeMaster Plus** and **HipMaster** can accommodate roof pitches from 3-12 to 12-12. For **RidgeMaster Plus 9"** and **HipMaster 9"** use the same specifications as **RidgeMaster Plus** and **HipMaster**.
- RidgeMaster** and **RidgeMaster Plus** can be used *only* for ridge installations, **NOT** for hip areas. For hip installations you **MUST** use **HipMaster**. **HipMaster** can also be used for ridge installations, for example, with wood and dimensional shingles.
- RidgeMaster, RidgeMaster Plus** and **HipMaster** must be used with an equal or greater amount of soffit ventilation (see "How to Figure Proper Ventilation" on bottom of Page 4).
- IMPORTANT:** Always use nails long enough (2½–3") to completely penetrate roof sheathing by at least ¼". This applies to installing both ridge vent and cap shingles. **3" nails are available from your Mid-America distributor** (sold separately). **ALWAYS WEAR SAFETY GLASSES DURING INSTALLATION.**
- All slot cut outs should end 12" from the outside wall, chimneys, ridge corners or hip joints. **HIP ROOF NOTE:** Hip slots should start halfway up the roof hip and end 36" from the top of the hip, unless joining up to a ridge vent, in which case hip slot cut outs can end 12" from ridge. In order to maintain maximum structural integrity, hip slot cut outs should be no more than 24" long and spaced about 12" apart (see Illustration A below).
- RidgeMaster** must always extend 10–12" beyond slot at beginning and end of ridge. For optimal roofline appearance run **RidgeMaster** and **HipMaster** along entire ridge and hip line to the terminal ends of the roof (as shown in Illus. B below). If there is no ridge to join up to, **HipMaster** should extend 36" beyond its slots in both directions with Starter Pieces on each end. (See **HipMaster** steps 14–19, page 6.)
- RidgeMaster, RidgeMaster Plus** and **HipMaster** each have an Overlap and an Underlap end that interlock when laid end to end in the proper orientation. This unites the 4 foot sections into a single, structurally integrated, weathertight system. Always start installing **RidgeMaster** with Overlap End on outside terminal end of ridge. (See Illustrations E, F and G on page 2 for identification of Overlap End). **IMPORTANT:** You should also complete your ridge vent installation with a **factory end** on the opposite terminal end of the ridge (see Steps 13 and 14 on page 4 for this technique).
- Baffles on underside of vents (see Illustration H on page 2.) **MUST ALWAYS** sit flush on flat part of shingle surface and not extend into slot area. To prevent weather penetration through gaps and ridges in architectural or dimensional shingles, baffles must sit flush on **upper flat part** of shingle **not** on raised dimensional part. This may require trimming the shingle and repositioning it in the **RidgeMaster** baffle area to maintain continuous baffle contact with a flat surface (see Step 12 on page 4). Failure to sit baffles properly could result in leakage of snow or water.

NOTE: These instructions are designed to meet most typical residential and commercial applications. However, no installation manual can cover all individual situations. For special situations and applications, please call Mid-America at 1-800-521-8486.

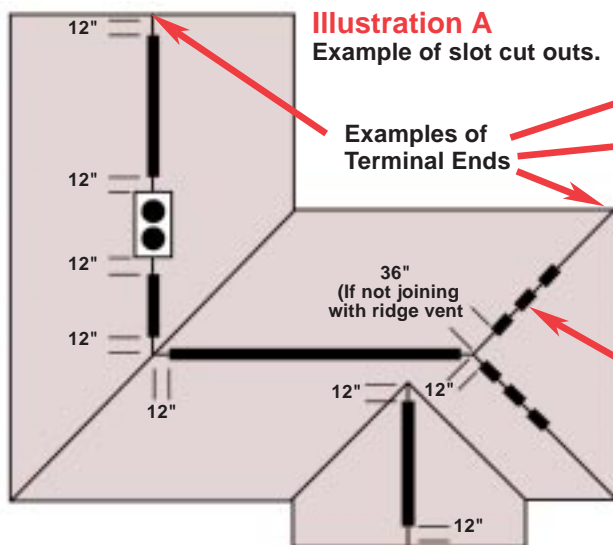

Illustration A
Example of slot cut outs.

Examples of Terminal Ends

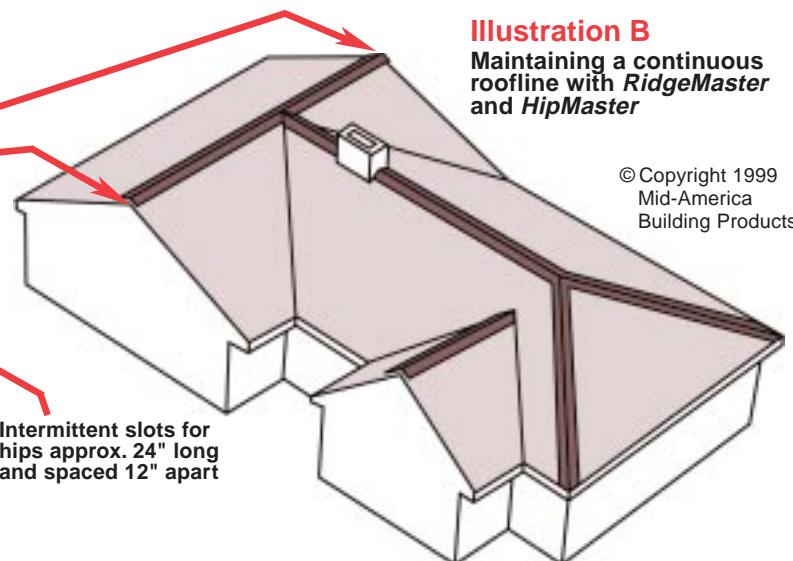

Illustration B
Maintaining a continuous roofline with **RidgeMaster** and **HipMaster**

© Copyright 1999
Mid-America
Building Products

Intermittent slots for hips approx. 24" long and spaced 12" apart

Slot cut outs (shown in black above) should stop 12" short of terminal ends and chimneys. Hip slots should be cut intermittently and begin half way up hip, stopping 12" from ridge if joining up to a ridge vent and 36" if there is no ridge vent to join up to.

All vents should extend beyond slots, but, for optimal appearance, extend ridge and hip vents to terminal ends of roof and join them where they meet. This creates a continuous roof line and a better looking installation.

Illustration C

Truss Roofs (No Ridge Boards)

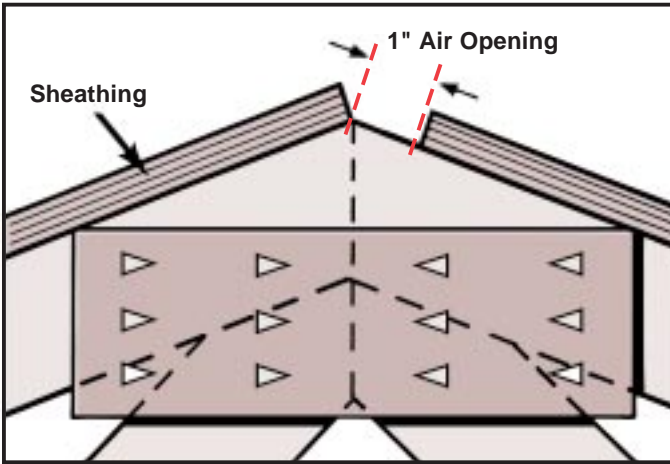

Plywood sheathing on truss roofs can be laid 1" short on one side at ridge or you may leave 1/2" air opening on each side of center for a 1" total air opening. *Any larger sized opening will not improve ventilation.* **REMEMBER:** Baffles must always be in complete contact with flat surface and not overlap slot.

Illustration D

Rafter Framed Roofs with Ridge Pole

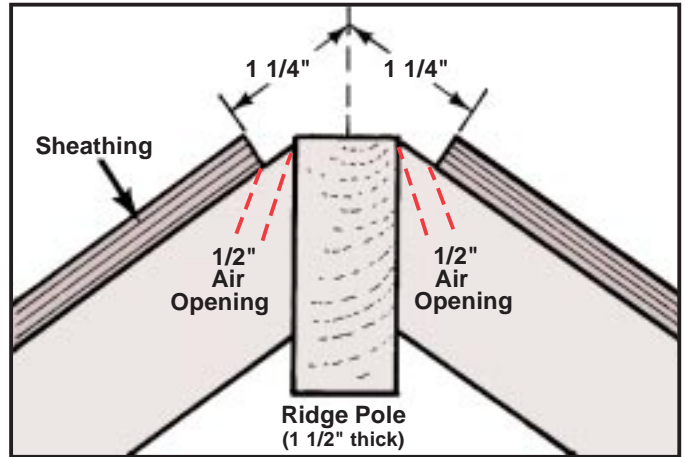

Cuts should be made to expose a 1/2" air opening between sheathing and each side of ridge pole. *Any larger sized opening will not improve ventilation.* **RidgeMaster, RidgeMaster Plus & HipMaster = 12.228 sq. in. per lineal foot—Net Free Ventilation.** (See page 4 also.)

Illustration E
RidgeMaster

Illustration F
RidgeMaster Plus & HipMaster*

NOTE: **RidgeMaster Plus 9"** and **HipMaster 9"** use the same specifications as **RidgeMaster Plus** and **HipMaster** with the exception of accepting 9" cap shingles instead of 11".

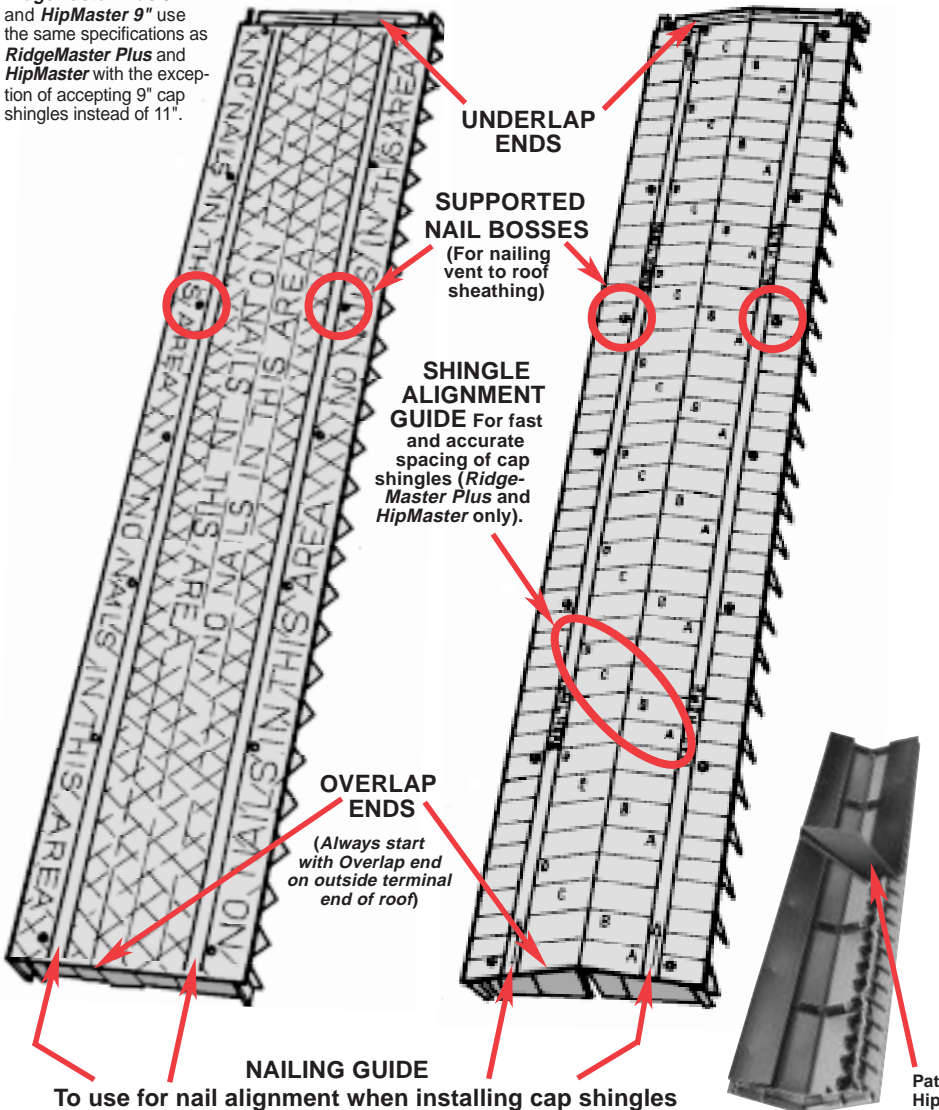

Illustration G
RidgeMaster

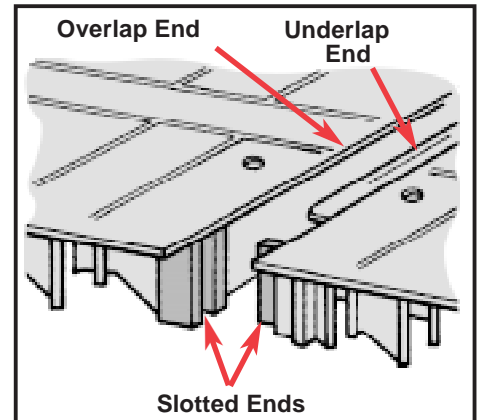
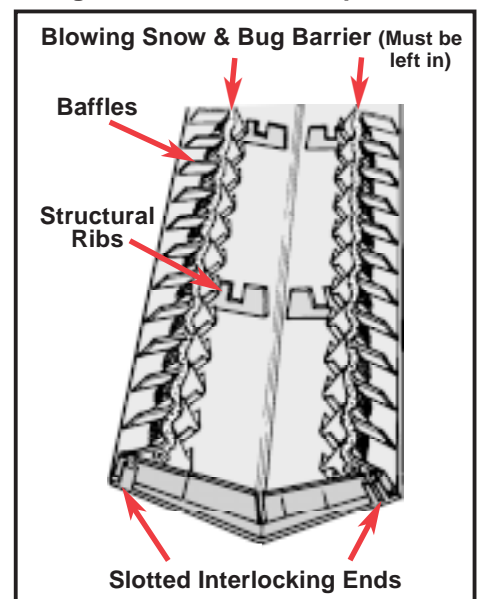

Illustration H
RidgeMaster Plus and HipMaster*



*HipMaster has an added baffle underneath—not shown above.

RidgeMaster and RidgeMaster Plus Installation

ALWAYS WEAR SAFETY GLASSES.

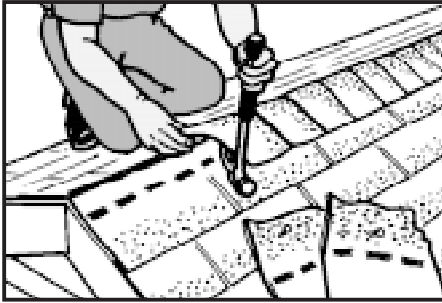

1 For retrofitting, remove existing cap shingles from roof. (For new construction, start with **Step 3a**). Always wear protective eye wear.

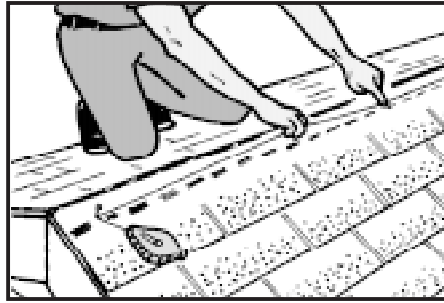

2 For ridge pole construction, determine a point that will expose a 1/2" air slot on each side of ridge pole. You may want to use a chalk line as a cutting guide. For truss roofs, see **Illus. C** on page 2.

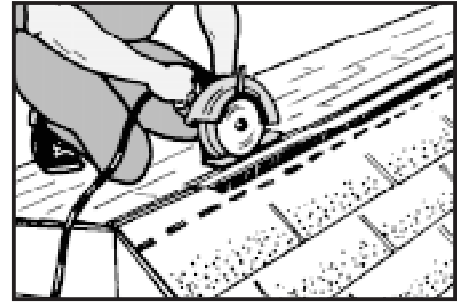

3 Use a circular saw to cut roof substrate along chalk line. Begin slots 12" from end of outside wall under roof. See **Illus. A** on page 1. Adjust saw depth so you don't cut rafters. Watch for nails when cutting.

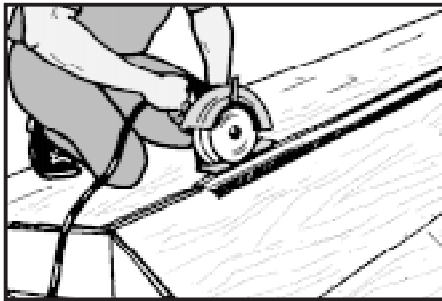

3a For new construction cut slots or set back plywood, then shingle roof so top course of shingles ends with flat area of shingle at ridge.

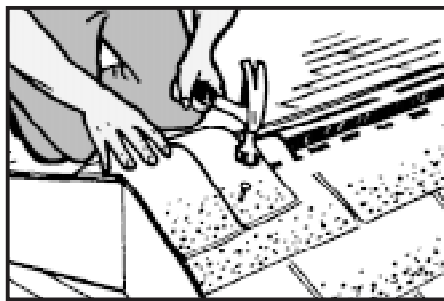

4 Install a minimum of **two** ridge cap shingles at all the terminal ends of the roof.



5 For **RidgeMaster**—Snip factory ends to fit your pitch. Usually no trimming is necessary for 3-12 to 6-12 pitches.

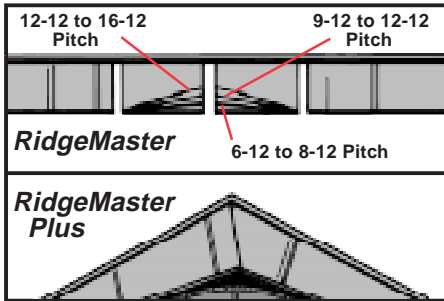

6 Pitch guides are given above for **RidgeMaster**. No trimming is required for **RidgeMaster Plus**.

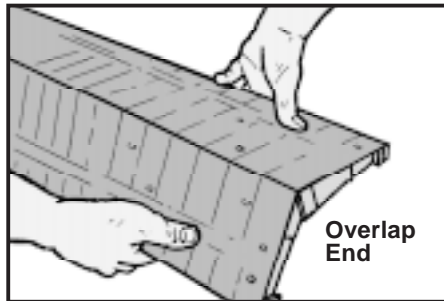

7 Flexing **RidgeMaster** and **RidgeMaster Plus** to preform the pitch makes installation easier. **IMPORTANT:** Always start with **Overlap end** on outside terminal end of roof.

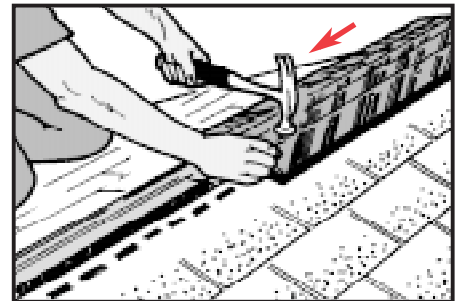

8 Start 2" from one end and begin nailing **Overlap end** of **RidgeMaster** to roof. Nail through supported Nailing Bosses. (See **Illustrations E and F** on page 2).

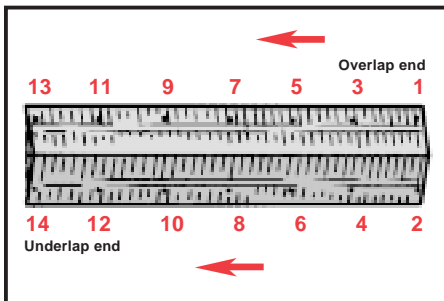

9 Recommended nailing sequence is to start from one end of vent and work to the other end alternating sides and nailing completely as you go. Keep vent shaped evenly or baffles will not sit flush on roof.

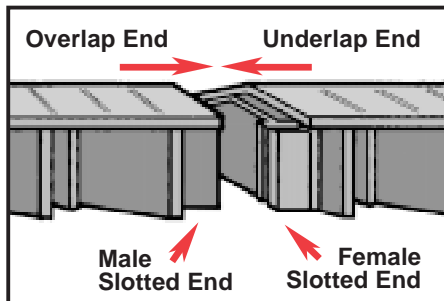

10 **RidgeMaster** vents join together with **Overlap** and **Underlap slotted ends** to prevent weather and insect infiltration. No caulking is necessary at these joints.

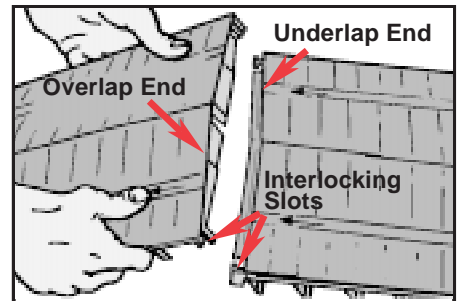

11 **RidgeMaster Plus** joins together with **Overlap** and **Underlap slotted interlocking ends** to prevent weather and insect infiltration. No caulking is necessary at these joints.

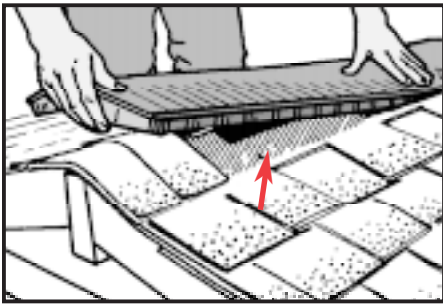

12 IMPORTANT: With laminated or architectural type shingles, the baffles on the underside of the vent **MUST** sit flush on flat part of shingles as shown and not on dimensional ridges and gaps part of shingle.

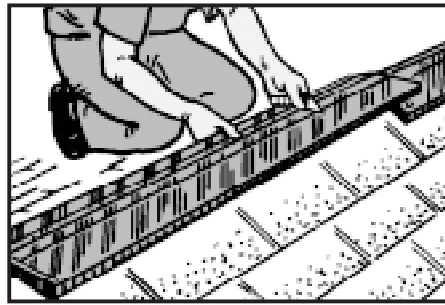

13 To end your ridge vent installation follow this procedure. If last piece of **RidgeMaster** needs to be cut because it is too long, measure length to be cut, add **1/2"** to measurement and cut off squarely with knife.

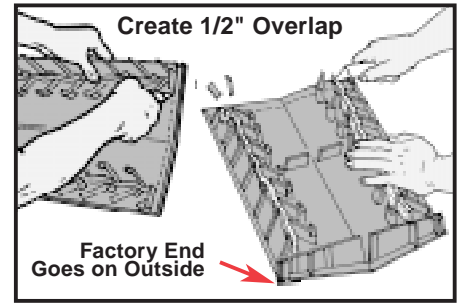

14 Knife back baffles on cut end about **1/2"** to create an overlap end. Join handmade end to last piece of vent installed making factory end the outside terminal end and finish by nailing to roof.

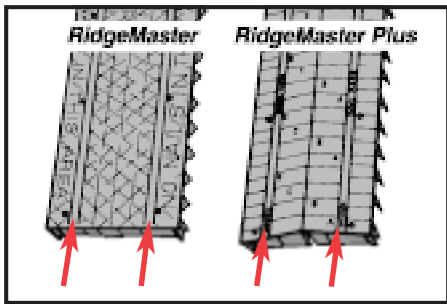

15 To nail cap shingles in place, use nail guide provided on vent labeled "Nail Here." (See illustration above). Make sure nails penetrate all the way through the vent and the roof sheathing by a minimum of **1/4"**.

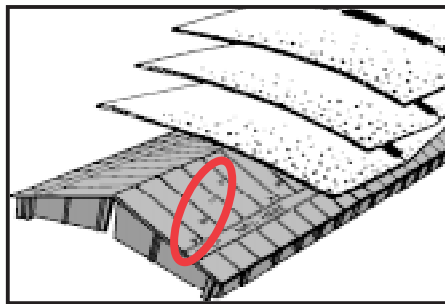

16 For **RidgeMaster Plus** use built in Shingle Alignment Guides to evenly space and square **11"** cap shingles on vent. For **RidgeMaster Plus 9"** and **HipMaster 9"** follow same guides but use **9"** caps.

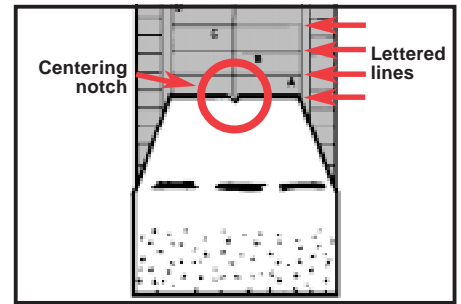

17 To ensure perfectly square placement of cap shingles align centering notch on back of shingle with center line along top of **RidgeMaster Plus**. Align back of shingle with horizontal lettered lines.

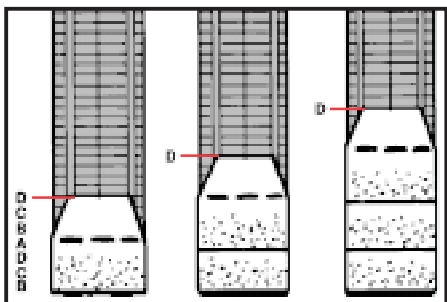

18 To evenly space cap shingles on **RidgeMaster Plus**, note whatever lettered line the back of your first shingle falls on then use the same lettered line for all the cap shingles. (See line "D" in example above).

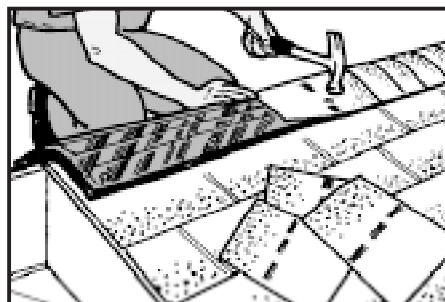

19 Nail all cap shingles in place using nails long enough to completely penetrate roof sheathing by **1/4"**.

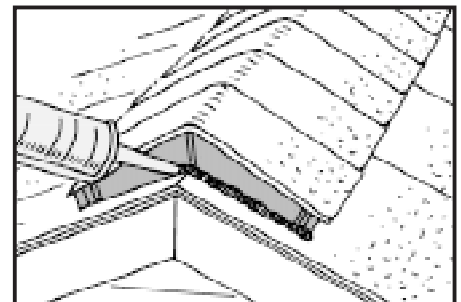

20 To complete installation, apply a good quality roof sealant to the outside terminal ends of **RidgeMaster** or **RidgeMaster Plus** where it meets the roof.

HOW TO FIGURE PROPER VENTILATION

Industry Standard for Proper Ventilation =

1 sq. ft. of ventilation for every 300 sq. ft. of attic space with 50% in ridge and 50% in soffit.

RidgeMaster, RidgeMaster Plus and HipMaster = 12.228 sq. in. per lineal foot—Net Free Ventilation

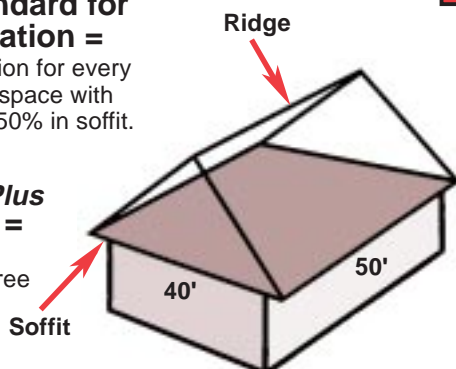

EXAMPLE: 2,000 sq. ft. attic

- 40' x 50' = 2,000 sq. ft. attic.
- 2000 sq. ft. ÷ 300 sq. ft. = 6.67 sq. ft. (total ventilation required)
- 6.67 x 144 = 960 sq. in. (conversion to inches)
- 960 sq. in. = $\left\{ \begin{array}{l} 480 \text{ sq. in. (ridge)} \\ + \\ 480 \text{ sq. in. (soffit)} \end{array} \right.$

A 50' ridge with RidgeMaster installed equals approximately 600 sq. in. of ventilation.

(More than industry standards)

HipMaster Installation

CAUTION: Before beginning installation, read all instructions and Special Notes sections thoroughly and be sure to check and follow all local codes. Failure to do so may result in improper installation and may void the homeowner's warranty.

SPECIAL NOTES:

1. Make sure you use only **HipMaster** on hips of roofs. **RidgeMaster** ridge vent is not designed for hip areas.
2. For best results use Starter Pieces (sold separately) to blend **HipMaster** into roof at bottom of hip. At top of hip, join **HipMaster** with **RidgeMaster** where possible. A template is provided on the box as a guide to make this easy. When top of hip vent does not join with ridge vent, terminate with another Starter Piece (see Steps 14–19, page 6).
3. **Slot Cut Outs:** It is not recommended to cut one continuous slot for hips. Proper ventilation and strength can best be obtained with intermittent cuts. Initial cuts should start halfway up the roof hip and end 12" from top of hip when joined with **RidgeMaster**, 36" from top of **HipMaster** when not joining to ridge. (See Steps 5–6 below and illus. A, page 1).
4. **CAUTION: HipMaster must always be installed with the arrows on all vents pointing up towards the top of the roof.** Failure to do so will result in leakage (see Step 9 below).
5. **A generous amount of roofing sealant must be applied** where the flat underside of the baffle on **HipMaster** contacts the roof in order to fill the gaps between the vent and the shingles that step down the roof (see Step 8).

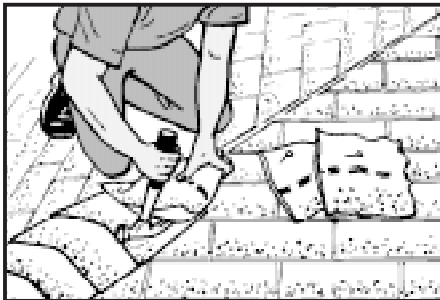

1 If retrofitting, remove existing cap shingles from ridge and hip. (New construction—skip **Step 1**). **ALWAYS WEAR SAFETY GLASSES.**

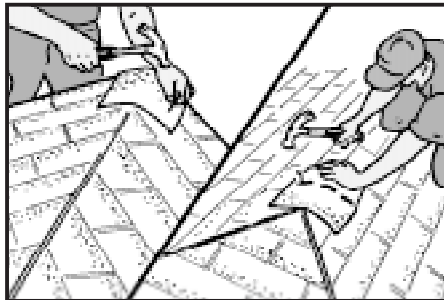

2 Install a minimum of two cap shingles at the bottom of each hip and at the terminal ends of each ridge if you will be installing **RidgeMaster** along with **HipMaster**.

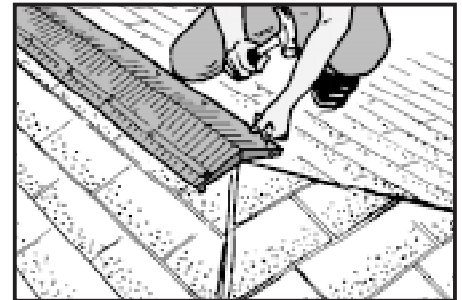

3 If your roof has a ridge, install **RidgeMaster** along entire ridge from hip joint to hip joint. (See **RidgeMaster** installation, but do not install ridge cap shingles on top at this time).



4 Snap two parallel chalk lines **2 1/2"** apart along entire hip (**1 1/4"** on each side of center). Cutting away shingles on these lines with a roofing knife will make following steps easier. **BE SURE TO WEAR SAFETY GLASSES.**

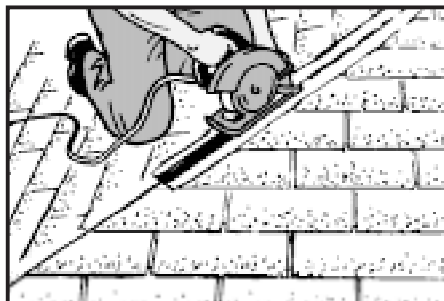

5 Cut slots on chalk lines starting halfway up roof hip and ending **12"** from top when joining with **RidgeMaster**. See step 14 for terminating with Starter Piece. See next step for cutting pattern. See **Illus. D** page 2 for slot air opening guidelines.

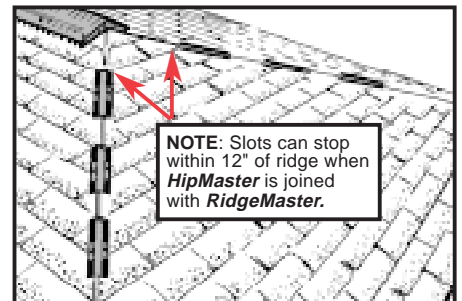

6 For hips, one continuous slot is not recommended. To maintain maximum roof strength, hip slots should be approximately **2 feet** in length, be spaced **1 foot** apart and extend halfway down the hip. Set saw depth to cut only sheathing not rafters.



7 Begin installing **HipMaster** by nailing Starter Piece in position. Round end goes at bottom of roof. There should **NOT** be a slot opening cut underneath Starter Pieces.

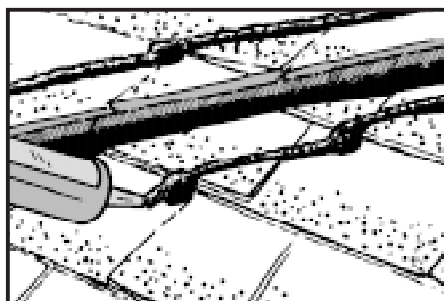

8 Before installing each vent apply roofing sealant in a line parallel to slot and **3/4"** away from it. Add generous amounts at low points particularly with dimensional shingles.

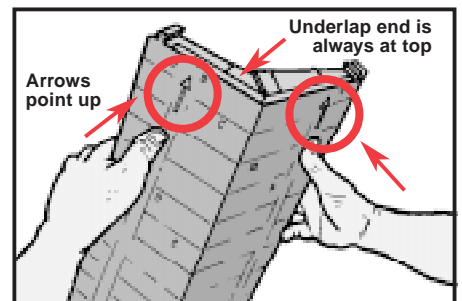

9 IMPORTANT: When installing **HipMaster**, make sure arrows on all hip vents point up towards top of roof and Underlap end is at top. Failure to do so will result in leakage.

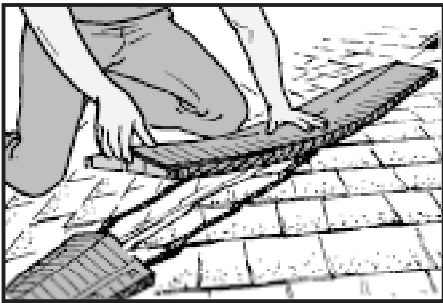

10 Lay **HipMaster** in position making sure there is good contact with roofing sealant. Ensure that all low points in shingles are filled with sealant. Failure to properly seal could lead to water intrusion.

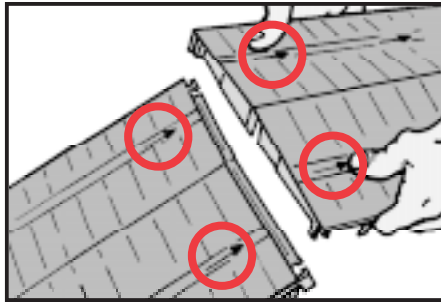

11 Always start with an Overlap end at bottom. Join vents together by interlocking the ends. **REMEMBER:** ALL arrows on all vents must point **UP** towards **TOP** of roof.

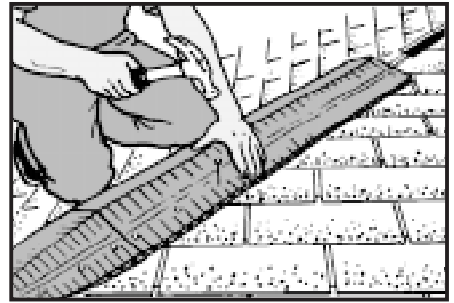

12 Make sure first vent is interlocked with Starter Piece and begin nailing in place, making sure nails penetrate at least **1/4"** through sheathing. (Refer to **Step 13** for nailing sequence.)

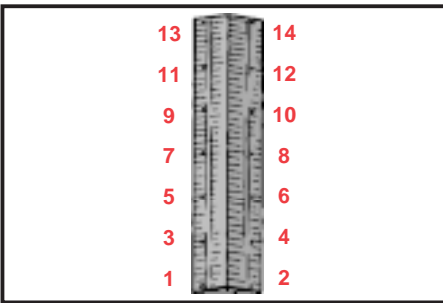

13 Recommended nailing sequence is from bottom to top of **HipMaster** and roof as indicated, alternating sides and nailing completely as you go up roof.

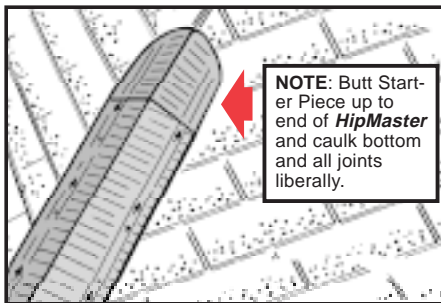

14 When there isn't a ridge vent to join with **HipMaster** at top of roof, use a Starter Piece to terminate vent. **Remember:** slot cut outs must stop **36"** from top end of **HipMaster** when terminated with a Starter Piece.

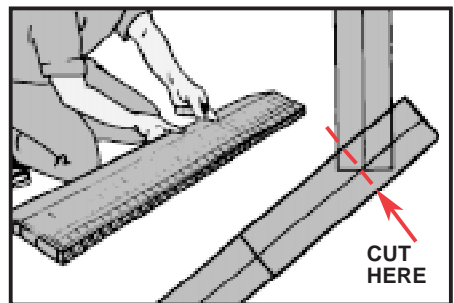

15 When hip and ridge vent are installed together, follow this method. Lay last piece of hip vent over top of ridge vent, measure where center of hip vent crosses center of ridge vent and cut hip vent square at this point.

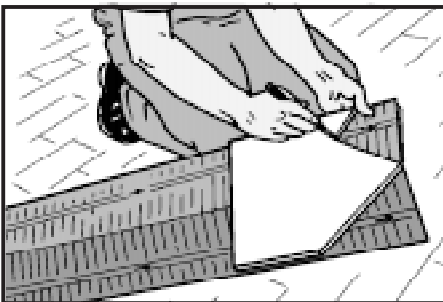

16 Carefully cut and remove mitre template from box and use guides to trim to your pitch. Place point of mitre template at square cut end of **HipMaster** and scribe line for cutting.

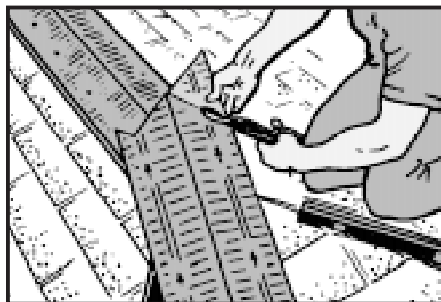

17 Cut **HipMaster** along scribed mitre lines with shears or knife to form proper hip to ridge mitre.

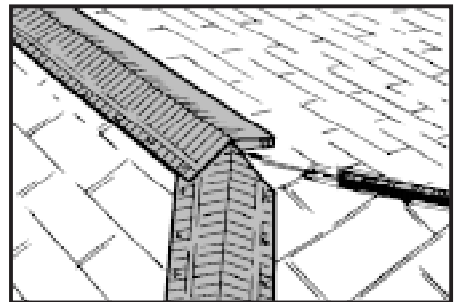

18 After applying roof sealant as in **Step 10**, lay down **HipMaster** and nail in place.

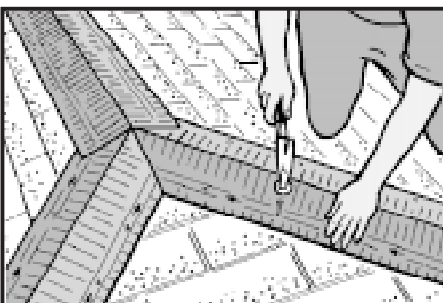

19 Repeat for other side. A tight mitre should result. If mitre is slightly open it should be sealed with roofing sealant.

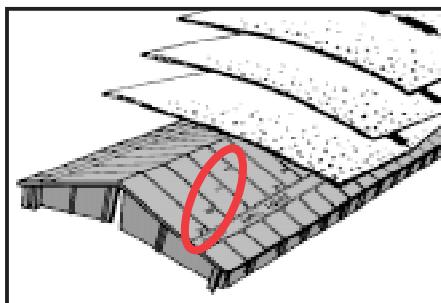

20 Use built-in Shingle Alignment Guides to evenly space cap shingles on **HipMaster**. See **Steps 16, 17, 18 and 19** on page 4 for further tips.



21 Nail all cap shingles in place working from bottom of hips to top of ridge. Finish by capping ridge. Apply a bit of roof sealant to last shingle where needed.

Special Applications of **RidgeMaster**® and **HipMaster**® For Residential, Commercial, New Construction or Reroofing

The following diagrams are intended as a general overview only. More extensive installation instructions are available for these applications and others from Mid-America. Call Mid-America at 1-800-521-8486 for more information.



Metal Roof



Slate Roof



Wood Shingle Roof

METAL ROOFING

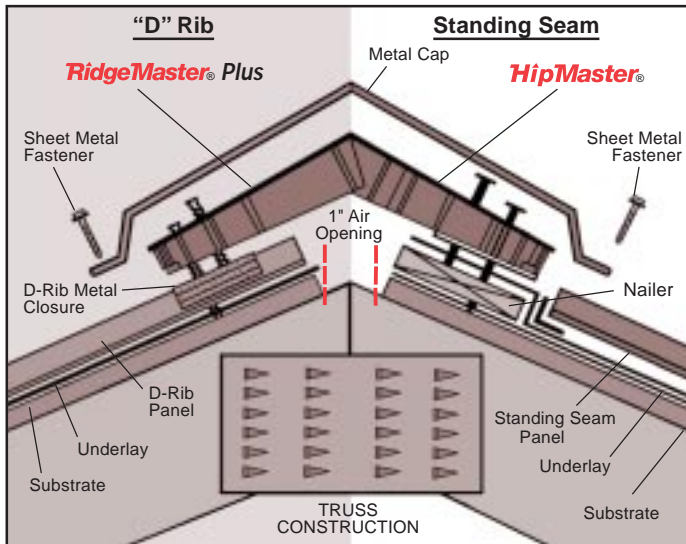

- Use **RidgeMaster Plus** or **HipMaster**.
- For use with D-rib or standing seam roofs.
- Adapts to ridge pole or truss construction.

SLATE ROOFING

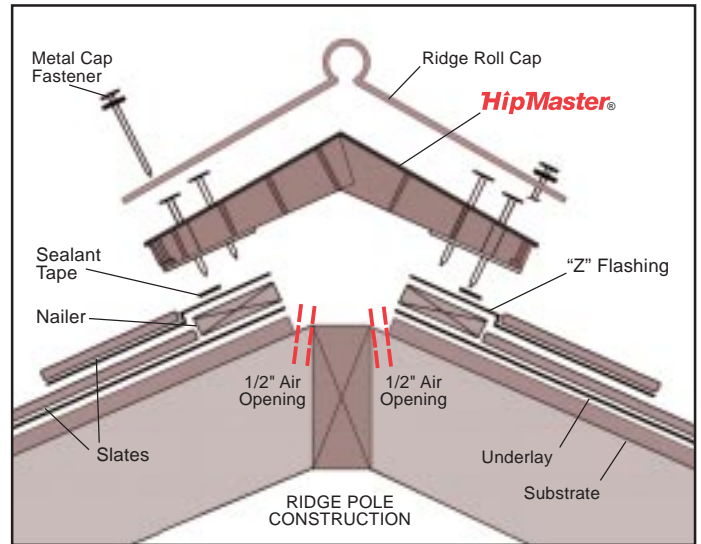

- Use **HipMaster**.
- For use with standard and textural slates.
- Adapts to ridge pole or truss construction.

WOOD SHINGLE ROOFING

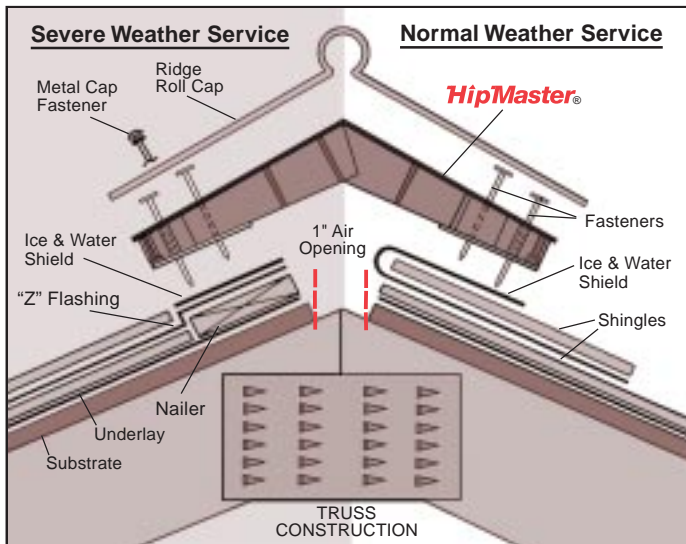

- Use **HipMaster**.
- Can be used with two types of shingles: Blue and Red label No.1 and No.2 Fivex-Perfections-Royals.
- Adapts to ridge pole or truss construction.

LAMINATE/WIDE BEAM

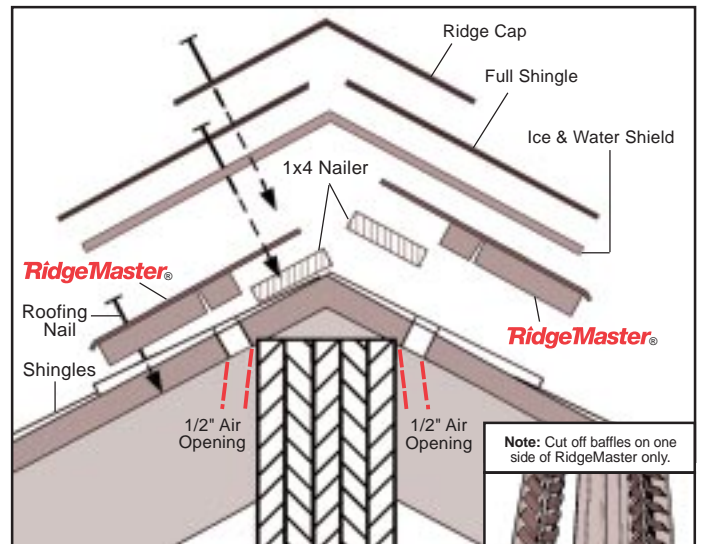

- Use **RidgeMaster**.
- To be used for wide ridge beams as often found in cathedral ceilings, firewalls, etc.
- Remove baffles and end pieces from one side of **RidgeMaster** (see inset at right).

Note: Cut off baffles on one side of RidgeMaster only.

